

FP-2
freeplace-2

thunderwood



TUSCANIA
ceramiche



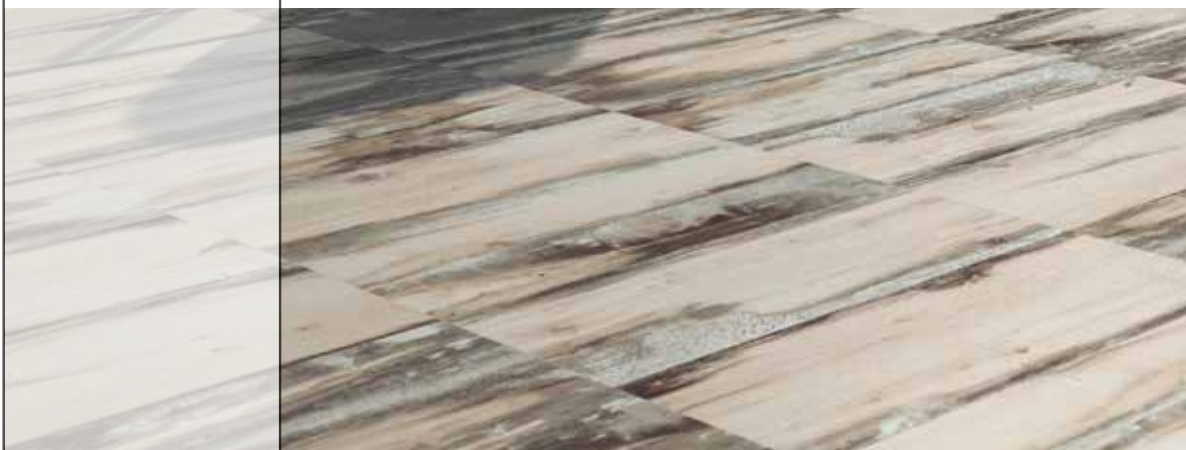

thunderwood



Spessore
Thickness
Épaisseur
Stärke
2 cm



grès porcellanato tutta massa
full body porcelain stoneware
grès cérame coloré dans la masse
durchgefärbtes feinsteinzeug

TUSCANIA
ceramiche





FP-2
freepiace-2

thunderwood

FP2 sandstorm
45x90 cm - 18"x36"

thunderwood



FP2 sandstorm
45x90 cm - 18"x36"



thunderwood

Grès porcellanato smaltato
Glazed porcelain stoneware
Grès cérame émaillé
Glasiertes Feinsteinzeug



R11
FP2

HD



R

Rettificato - Rectified

N

Naturale - Natural



45x90 cm N . 18"x36" N
45x90 cm R . 18"x36" R

thunderstruck



45x90 cm 18"x36" FP2

55,56 **N**

45x90 cm 18"x36" FP2

67,90 **R**

sandstorm



45x90 cm 18"x36" FP2

55,56 **N**

45x90 cm 18"x36" FP2

67,90 **R**

FP2 pezzi speciali - special pieces - pièces spéciales - formteile

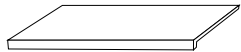

elemento "L"
45x90x5 cm 18"x36"x2" **112,65/PZ**

sandstorm _____
thunderstruck _____

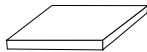

angolare elemento "L"
45x45x5 cm 18"x18"x2" **128,09/PZ**

sandstorm _____
thunderstruck _____

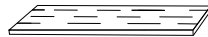

griglia
20x90 cm 8"x36" R **128,09/PZ**

sandstorm _____
thunderstruck _____



angolo SX
griglia angolo 20x90 cm R 8"x35^{3/4}" R **290,12/coppia**

sandstorm _____
thunderstruck _____

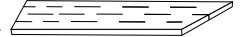

angolo DX

sandstorm _____
thunderstruck _____

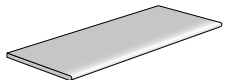

round lineare
45x90 cm 18"x36" **104,94/PZ**

sandstorm _____
thunderstruck _____

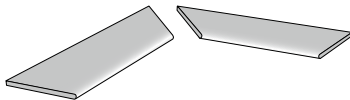

angolo SX
round angolare 45x90 cm 18"x36" **256,17/coppia**

sandstorm _____ sandstorm _____
thunderstruck _____ thunderstruck _____

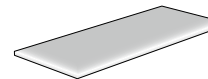

angolo SX
angolo bordo toro 45x90 cm 18"x36" **152,78/PZ**

sandstorm _____
thunderstruck _____

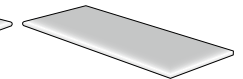

angolo DX

sandstorm _____
thunderstruck _____

Note - Notes - Notes - Anmerkungen

I pezzi speciali FP2 vengono venduti al pezzo e solo su ordinazione (tempo minimo di consegna 20 gg lavorativi dall'ordine)
The special pieces FP2 are sold by piece and only on request (minimum delivery time 20 working days from date of order).
Les pièces spéciales FP2 sont vendus à la pièce et uniquement sur commande (délai minimum de livraison 20 jours ouvrés à partir de la commande).
Spezial Teile FP2 sind pro Stück verkauft und nur auf Bestellungen produziert. (Lieferzeiten mindesten 20 arbeitstage ab Auftragsbestätigung)

Tipologia di supporti per la posa sopraelevata
 Type of supports for raised floor laying
 Typologie de supports pour la pose surélevée
 Trägerart für die Verlegung als Doppelboden



Supporto fisso . Fixed support
 Support fixe . Fester Träger



Supporto regolabile . Adjustable support
 Support réglable . Höhenverstellbarer Träger



Supporto autolivellante . Self-levelling support
 Support auto-nivelant . Selbstnivellierender Träger

Esempi di posa . Laying scheme examples . Exemples de pose . Verlegebeispiele

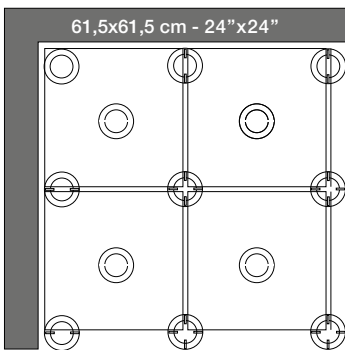

Supporti regolabili e supporti autolivellanti

Adjustable supports and self-leveling supports
 Supports réglables et supports auto-nivelants
 Höhenverstellbarer Träger und Selbstnivellierender Träger

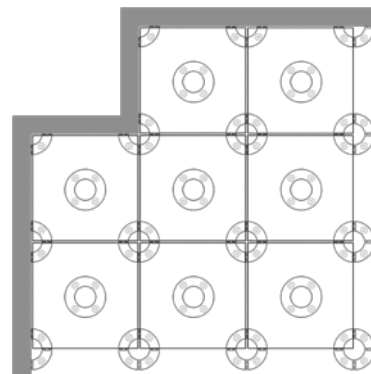
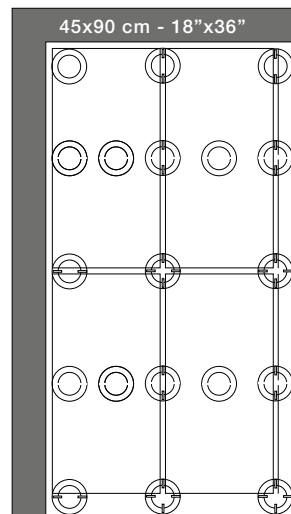

Supporti fissi

Fixed supports - Support fixe - Fester Träger

SUPPORTI SUPPORTS SUPPORT TRÄGER	ALTEZZA HEIGHT HAUTEUR HÖHE
SUPPORTO FISSO FIXED SUPPORT SUPPORT FIXE FESTER TRÄGER	15 mm
SUPPORTO REGOLABILE ADJUSTABLE SUPPORT SUPPORT RÉGLABLE HÖHENVERSTELLBARER TRÄGER	25 - 40 mm
SUPPORTO AUTOLIVELLANTE SELF-LEVELLING SUPPORT SUPPORT AUTO-NIVELANT SELBSTNIVELLIERENDER TRÄGER	37,5 - 50 mm

Suggerimenti per la posa flottante

Raccomandiamo l'uso di un supporto centrale alla lastra al fine di distribuire in modo omogeneo i carichi.

Tips for floating installation

We recommend the use of a central slab support in order to distribute the loads equally.

Conseils pour la pose flottante



Nous recommandons l'utilisation d'un support central sous la dalle afin de répartir uniformément les charges.

Empfehlungen für die schwimmende verlegung

Wir empfehlen die Verwendung von in der Mitte anzubringenden Stützen, damit die Belastung gleichmäßig verteilt wird.

Tabella pesi ed imballi - Sizes weight and packaging

Mesures poids et emballages - Tabelle der Gewichte und Verpackungen

formati - sizes - tailles - formate		pz. x box	mq. x box	kg. x box	box x pal.	mq. x pal.	kg. x pal.	
45x90 cm 18"x36" FP2 (naturale)	20 mm	2	0,81	36,5	27	21,87	995	100x120x55
45x90 cm 18"x36" FP2 (rettificato)	20 mm	2	0,81	36,5	27	21,87	995	100x120x55

Note - Notes - Notes - Anmerkungen

I battiscopa vengono venduti a pz. e a scatola completa. Tutti gli altri pezzi speciali vengono venduti al pezzo.
I gradini vengono prodotti solo su ordinazione (tempo minimo di consegna 20 gg lavorativi).

Skirtings are sold by piece and full boxes. All other special trims are sold by piece.
Steps are produced only on request (minimum delivery terms of 20 days).

Les plinthes sont vendues la pièce et par boîte complete. Les autres pièces spéciales sont vendus la pièce.
Le plat de marche sont produit sur demande (délai minimum de 20 jours).

Die Sockelleisten werden pro Stk. und Vollen Kartons verkauft.
Stufen und Stufenecken werden nur auf Bestellung produziert (Lieferzeiten mindesten 20 arbeitstagen ab Auftragserteilung).

simbologia caratteristiche tecniche - symboles technical characteristics -
 symboles des caracteristiques techniques - symbole technischen eigenschaften

TUSCANIA
 ceramiche

	CARATTERISTICHE TECNICHE TECHNICAL CHARACTERISTICS CARACTÉRISTIQUES TECHNIQUES TECHNISCHE MERKMALE	NORMA DI RIFERIMENTO REFERENCE STANDARD NORME DE REFERENCE PRÜFMETHODE	VALORE RICHIESTO REQUIRED VALUE VALEUR REQUISE SOLLWERT	VALORE MEDIO TUSCANIA AV. TUSCANIA VALUE VALEUR MOYENNE TUSCANIA MITTLERER TUSCANIA-WERT	
	DIMENSIONI DIMENSIONS DIMENSIONS ABMESSUNGEN	ISO 10545-2	CONFORME COMPLIANT CONFORME KONFORM	CONFORME COMPLIANT CONFORME KONFORM	
	ASSORBIMENTO D'ACQUA WATER ABSORPTION ABSORPTION D'EAU WASSERAUFNAHME	ISO 10545-3	≤ 0,5 %	<0,4%	
	RESISTENZA A FLESSIONE MODULUS OF RUPTURE RESISTANCE A LA FLEXION BIEGEFESTIGKEIT	ISO 10545-4	MODULUS OF RUPTURE R ≥ 35 N/MM ² BREAKING STRENGTH S ≥ 1300 N	R > 50 N/mm ² S > 2500 N	
	DUREZZA SUPERFICIALE SCRATCH RESISTANCE DURETE SUPERFICIELLE KRATZFESTIGKEIT	ISO 10545-7	0 - V	IV	
	DILATAZIONE TERMICA LINEARE LINEAR THERMAL EXPANSION DILATATION THERMIQUE LINEAIRE LINEARE WÄRMEAUSSCHWUNG	ISO 10545-8	≤ 9x10 ⁻⁵ °C ⁻¹	6x10 ⁻⁵ °C ⁻¹	
	RESISTENZA AGLI SBALZI TERMICI THERMAL SHOCK RESISTANCE RESISTANCE AUX ECARTS DE TEMPERATURE ITEMPERATURWECHSELBESTÄNDIGKEIT	ISO 10545-9	RESISTENTE RESISTANT RESISTANT BESTÄNDIG	RESISTENTE RESISTANT RESISTANT BESTÄNDIG	
	RESISTENZA AL GELO FROST RESISTANCE RESISTANCE AU GEL FROSTBESTÄNDIGKEIT	ISO 10545-12	RESISTENTE RESISTANT RESISTANT BESTÄNDIG	RESISTENTE RESISTANT RESISTANT BESTÄNDIG	
	RESISTENZA AGLI ACIDI ED ALLE BASI ACID AND ALKALI RESISTANCE RESISTANCE AUX ACIDES ET AUX BASES SÄURE- UND LAUGENBESTÄNDIGKEIT	ISO 10545-13	CLASS GB MIN.	LOW CONCENTRATION GLA HIGH CONCENTRATION GHA	
	RESISTENZA ALL'ATTACCO CHIMICO CHEMICAL RESISTANCE RESISTANCE À L'ATTAQUE CHEMIQUE CHEMISCHE BESTÄNDIGKEIT	ISO 10545-13	CLASS GB MIN.	GA	
	RESISTENZA ALLE MACCHIE STAIN RESISTANCE RESISTANCE AU TACHES FLECKENBESTÄNDIGKEIT	ISO 10545-14	CLASS 3 MIN.	5	
	COEFFICIENTE DI ATTRITO (SCIVOLOSITÀ) FRICTION COEFFICIENT (SLIPPERINESS) COEFFICIENT DE FRICTION (GLISSEMENT) REIBUNGSKOEFFIZIENT (RUTSCHIGKEIT)	BCR - ITALIA DM DEL 14-06-89	ASTM - USA ASTM C1028	DIN - GERMANIA DIN 51130	
		DRY RUBBER 0,62	WET RUBBER 0,51	DRY LEATHER 0,62	DRY NEOLYTE 0,69
THE PRODUCTS HAVING AN ABSORPTION < 0,5% ARE CLASSIFIED ACCORDING THE UNI CEN STANDARDS "FULLY VITRIFIED TILES" AND ACCORDING TO THE ASTM STANDARDS "IMPERVIOUS TILES"					



Tuscania S.p.A.
Via Giardini Sud, 4603 - 41028 Serramazzoni (Mo) - Italia
Tel. +39 0536.952399 - Fax +39 0536.954716
info@tuscaniagres.it - www.tuscaniagres.it

